







360° Suspended LED Tube Light 6000K

SPECIFICATION SHEET

12W	24V DC	480 LED/M	360° Beam	807LM	IP20
 POWER SUPPLIES	 PROFILES	 CONNECTORS		 ROHS COMPLIANT	 5 YEAR WARRANTY

■ PRODUCT SPECIFICATION

Power consumption	12W / m
Voltage	24V DC
LED/M	480
Kelvin	6000K
Lumens	807lm
Length	150mm >> 2000mm
Diameter	40mm
PCB increment	Power connection and cut point every 50mm
Beam angle	360°
Frame Material	aluminium
Lens Material	polycarbonate
LED Chip	5050 SMD epistar
CRI	85+
Lifetime	50,000hrs @ 70%
Operating temp.	-20 ~ 45°C
IP rating	IP20
Bin/step	3 Step MacAdam ellipse
Connection	Hardwire tails or male/female connectors
Control	0-10V/1-10V/DMX/DALI/RF
Mounting	Metal mechanical fixing



■ PERFORMANCE DATA (for 1000mm)

Power consumption	12W
Supply voltage	24V DC
Supply current	0.5A

■ CHROMATICITY DIAGRAM

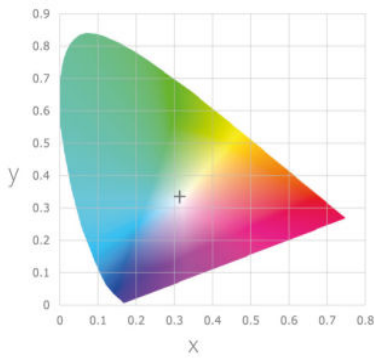

■ SPECTRAL RADIANT FLUX VERSUS WAVELENGTH

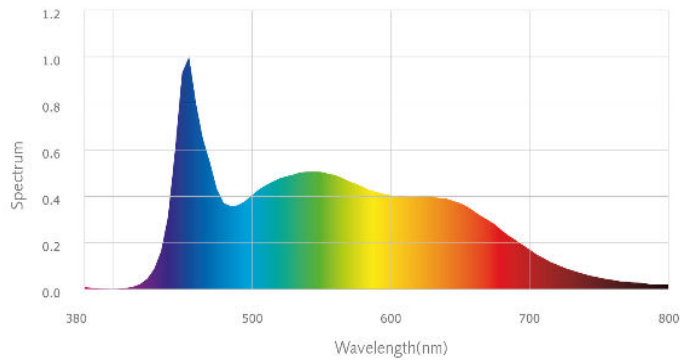

■ TECHNICAL DRAWING

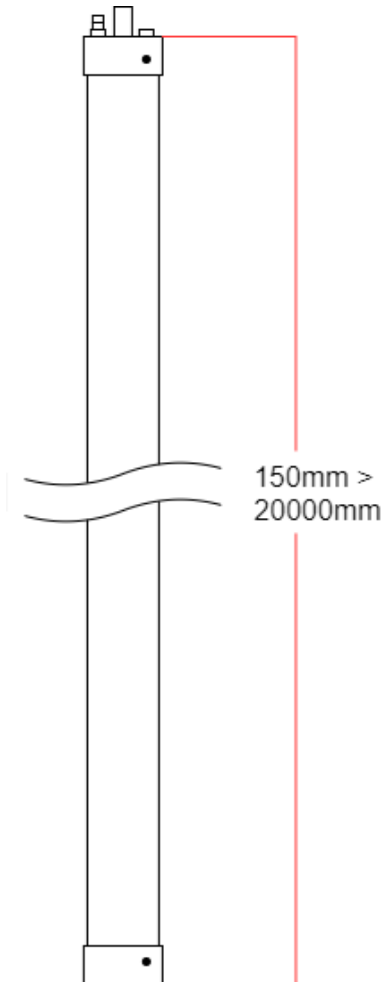

■ WIRING DIAGRAM

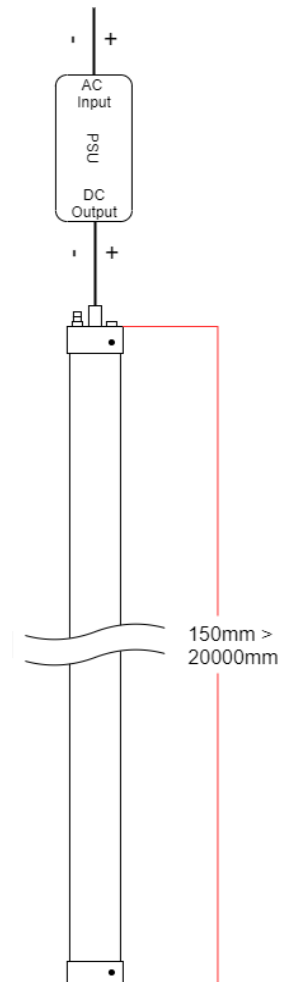

360° Suspended LED Tube Light 6000K

SPECIFICATION SHEET

■ PRODUCT DETAILS

Product name	360° Suspended LED Tube Light 6000K
Product code	360-LED-Tube-Susp
Description	360° Suspended LED Tube Light, 6000K, 24V,12W/m

■ PRODUCT Features

- 360° diffused light output
- High Quality Branded LED Chip
- Sturdy aluminium / polycarbonate build
- Smooth linear effect
- Wide range of colour / brightness options

■ PRODUCT DESCRIPTION

Creating a smooth, even and attractive glow all the way around (full 360° output), this versatile free-standing LED tube light is available in a range of white-light shades and single-colour options (12-watts, 24V). The Suspended LED tube-light can be supplied in any bespoke length up to 2 metres – whatever your project requires. The tube is constructed from sturdy aluminium and light-diffusing polycarbonate, and offers a choice of end-cap finishes in either silver effect, black or white polycarbonate

■ PRODUCT Application

The 360° LED tube light range is ideal for almost any commercial application, including store fronts / restaurants / clubs / bars / hair salons / offices and more.



■ INSTALLATION & OPERATING INSTRUCTIONS

1. Please handle carefully during installation.
2. Please read the wiring instructions carefully before turning the 360° tube on.
3. The 360° LED Tubes must not be bent.
4. The 360 Tube may not be: twisted, bent at a angle, shaken or stood on.

■ PRODUCT EXTRAS

End Caps



Silver



Black



White

■ IMPORTANT INSTALLATION INFORMATION

- Installation should be carried out in accordance with the latest edition of the National Wiring Regulations. If in doubt, consult a qualified electrician.
- Handle with care
- When installing, be sure to allow for later access to all products (in the event of replacement/refits).
- Attention shall be paid to the positive and negative poles of the wires during installation, and whether the power supply conforms to required voltages. This is essential to avoid damage.
- Be careful not to scratch, distort, or irregularly bend / twist during installation. Otherwise you may cause irreparable damage to the product.
- If the actual length of the LED exceeds the specified maximum length, it will lead to overload, overheating and uneven brightness.
- The LED Tubes are designed for internal use only.
- Multiple LED tubes can be wired into one power supply as long as the total wattage of all LED Tubes does not exceed the wattage of the power supply.
- Keep the LED driver away from all direct heat sources – e.g., low-voltage lamps.
- LED drivers must have unobstructed airflow, with a minimum area space of 100mm.

Parallel Wiring Diagram

