





# Tube Surface LED Tape Extrusion

SPECIFICATION SHEET

1M / 2M	Silver / White	Fixing Clips	End Caps	Semi Diffused Cover
 POWER SUPPLIES	 CONNECTORS	 CE	 ROHS COMPLIANT	 5 YEAR WARRANTY

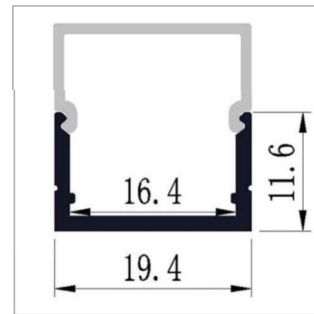

## ■ PRODUCT SPECIFICATION

IP rating	IP22
Warranty	5 Years
Certificated	CE + RoHS
Length	1M or 2M
Width	19,4mm
Depth	11,6mm (excl. cover)
Colour	Buffed Silver / White
Material	Base - Aluminum / Cover - Polycarbonate
Included	1 x Base / 1 x Cover / 2-4 End Caps / 2-4 Fixing Clips

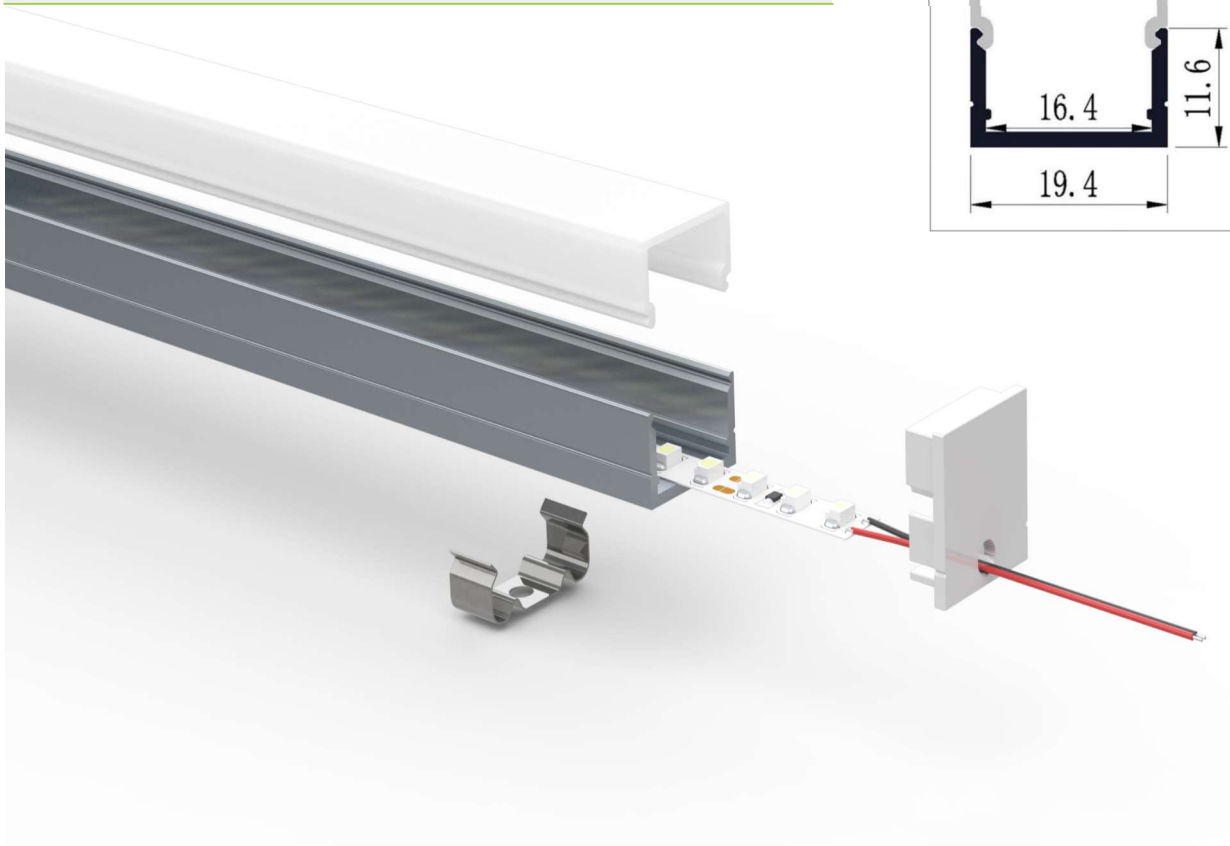

## ■ PRODUCT DETAILS

Product name	Tube Surface LED Tape Extrusion
Product code	P-TU-1 / P-TU-2
Description	1m / 2m Tube Surface Extrusion for LED Tape

## ■ PRODUCT Features

- Commercial Grade
- Ideal for internal use
- Available in aluminium (buffed silver) or white finish

## ■ PRODUCT DESCRIPTION

An aluminium extrusion designed to accommodate any of our LED tapes. Its dimensions are 19.4mm (width) and 11.6mm (excl. cover) (depth). The extrusions can be butted up together to give a continuous effect.

Because of its diffused cover and deepness, your deep surface mounted extrusion is ideal in highly visible locations, as it emits a continuous light glow by obscuring the individual diodes that you normally see on the LED tape. (Otherwise, to give a continuous glow you would need to shine the LED tape onto an appropriate surface.)

## ■ PRODUCT Application

Fixing your LED tape into an extrusion can create a more 'finished' look when compared to the unhoused PCB – which is ideal if the product is clearly on show. Extrusions can help to prevent contact damage if the LED tape is positioned easily within reach. And even though they are not waterproof, extrusions can help prevent moisture. (To provide more protection against water, consider installing IP67 LED tape in the extrusions.)

60 LED / M Illumination



120 LED / M Illumination



240 LED / M Illumination



## Installation Options:

1/ Use the fixing clips provided. Fixing clips should be screwed in position on the wall or other surface. The extrusion can then be securely snapped into the fixing clips.

2/ Use foam sticky tape backing (not provided, available separately). Stick the foam backing tape to the underside of the extrusion, and then place the extrusion in position on the wall or other surface. Apply pressure until the adhesive has set.

3/ Screw the profile directly to the wall or other surface. You can countersink screws through the aluminium profile easily. Drill a hole first, and make sure the screws are tightened to fit as flush as possible.

## Cutting To Length:

Use a mitre saw or hand saw.

Before sawing, you should tape the profile's cover to the base securely, so that there is no movement. You can then cut through both the base and the cover together. This should ensure they remain an exact fit.

You can make your cuts at any angle(s) that you require. This makes it a simple task to install your LED profiles around corners (90 degrees, or whatever angle you need) or around other obstacles by butting the two angled extrusion lengths together.

## Top Tip:

If you are installing multiple profiles in a continuous linear run, it's best to stagger (overlap) the diffused covers to the aluminium bases. This will mean the joints between the covers are at a different position to the joints between the bases, which will be more robust and look more attractive.

## Important Installation Advice:

Do not twist or bend the extrusion or cover.

Handle with care - be careful not to scratch the diffused cover.

If installing externally, be sure to use the extrusions only with IP67-rated LED strip lights.

If installing externally, water will get into the profile. To allow moisture to disperse, drill one or more drainage holes in the base of the extrusion.

Do not use LED strips that are wider than the internal width of the LED extrusion. Forcing the LED strips into the extrusion may damage them.

Do not get any substances on the diffused cover (such as silicone or paint).

## Side View

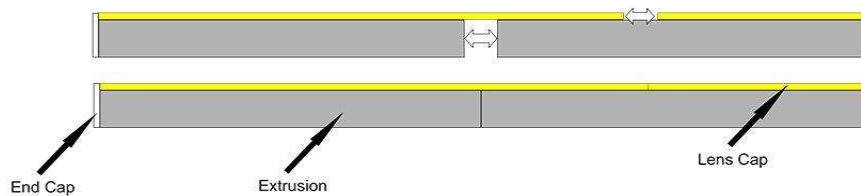

## Plan View

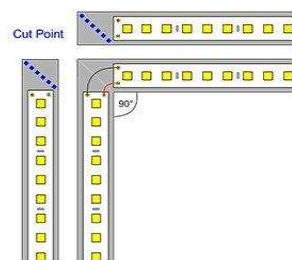

## Plan View

